

# PR-3 Multi-Functional Compact Magnetic Valve

**CHOARGER** 多機能小型油壓電磁閥

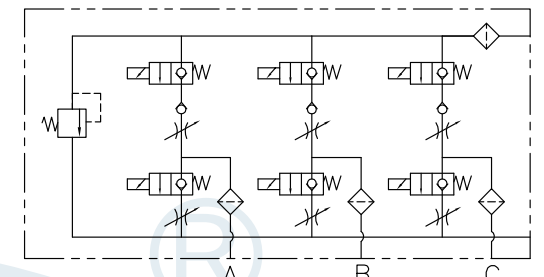
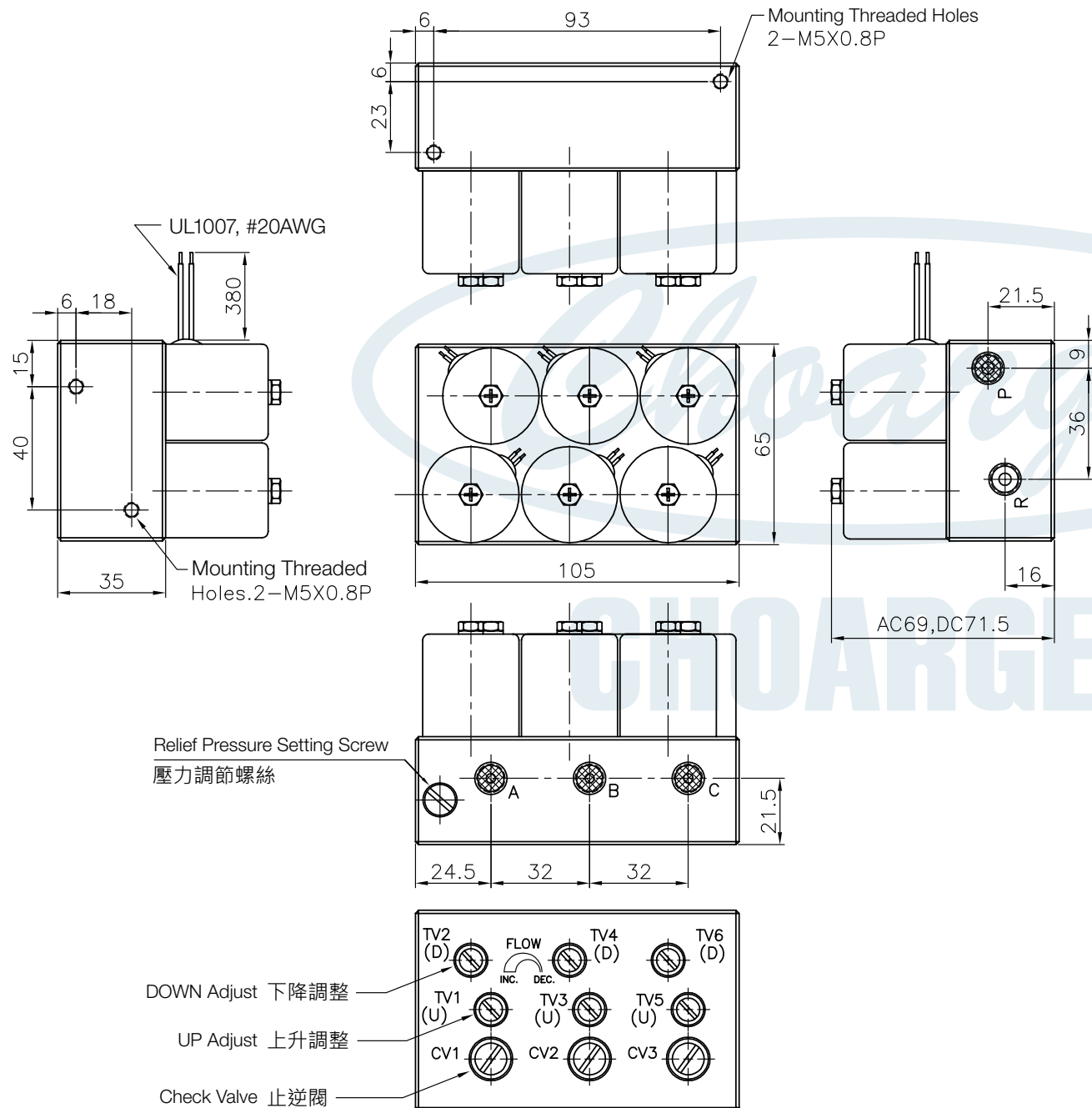

Diagram  
油路圖

Function 功能	
• Check Valve	止逆閥
• Speed Adjust	速度調整
• Pressure Adjust	壓力調整

機種 Model	PR-3
材質 Material	Aluminum 鋁體
額定壓力 Max Operating Pressure	70 kgf/cm <sup>2</sup> (7MPa)
接管規格 Threaded connection	PT" 1/8 ; NPT" 1/8
電壓 Voltage	AC24V/AC115V/AC230V DC12V / DC24V
額定時間 Rating time	10 min
重量 Weight	1.30 kg